

The art of Paperarchitecture (PA).

MANUAL

Introduction

Paperarchitecture (PA) is the art of creating three-dimensional (3D) objects out of a plain piece of paper or cardboard.

At first, a design is drawn (manually or printed (using graphical software) on paper or Cardbord. In the next steps-by cutting and folding this design-a 3D object gradually arises A lot people in the world are engaged in PA, in a way that can vary from simple Passtime (hobby) to exquisite craftsmanship (Art).

A lot of information about this hobby/art, can of couse be found on the internet. For Beginners there are a lot of ready-made models to be found (books, internet, on request from other people). Of course, the real pleasure and satisfaction will be experienced when one creates one`s own designs and consequently cut and fold themm into 3D pieces of art. But to get started and easily learn about the techniques of designing, cutting and folding it is wise to try out such simple models first (appendix 1), before attacking more complicated ones

Requisites and tools:

- Metallic/aluminium ruler,for straight and precise cutting, preferably having an underside equipped with rubber strip, to avoid slipping;
- Cutting-mat A3;
- Knife with sharp blade and point, to be able to cut with high precision;
- Instead of a knife, one could use a metallic pen to create the folds, but these will be leess sharp;
- Puncture pen, pencil, gum,adhesive, graph paper;.
- Magnifying glass;
- Common paper – I use Simili-japon paper, 225 grams;
- Paper to make test models, plain white, 160 grams.

Preparation

When making a 3D object, we must first determine what we want to do and how we are going to do it:

A - Using existing models:

1 - Find a design you like in PDF format (or equivalent) so you can print it on common Paper straight away and you will be able to start cutting

1a - If you do not have a computer, you can also use a drawing and then copy it By using carbon paper. (See further explanation below).

- 2 - To create a design, I myself use more expensive paper, but at first I make some test models on cheaper, plain white paper 160grams, in order to determine if any problems occur while folding, which enables me to find out if the design needs any adjustments. Because the test model is primarily meant to get a good idea of the ultimate design, I only cut the main lines, to keep it rather simple to fold the model. windows and other decorations are not yet cut in this test phase.

B - Making your own design on graphpaper:

- 1- Look for a model to make.
- 2- Decide which paper (colour, quality) you want to create the model from.
- 3- Make a design on the paper you have chosen (I advice to make a test model first)

The easiest and most used method to transmit the design is using carbon-paper, or something equivalent (see image 1).

There are other possibilities to transmit the design, but I find these too time-consuming to describe here .

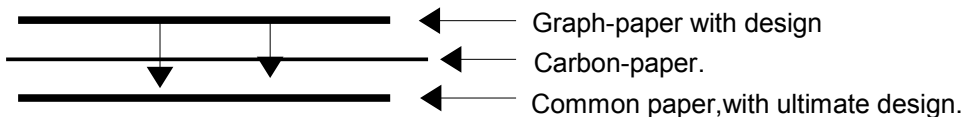

Image 1

C - Making a design by means of graphical software:

- 1- Look for a model to create.
- 2- OpenOffice offers a free programme which you can download from their internet-site [Http://www.openoffice.org](http://www.openoffice.org)

It might take some time to get to know the programme, but it will be worth your while afterwards.

The big advantage is that this programme enables you to make quick adjustments to your design, and to share you designs with the rest of the world by internet.

Cut – and fold lines

When creating a design, different types of line are used to indicate the exact, Places where cuts / folds are to be created.

For piratical reasons, I prefer to draw coloured line to make these distinctions.

- 1) - - - - - of green lines indicates a mount-fold

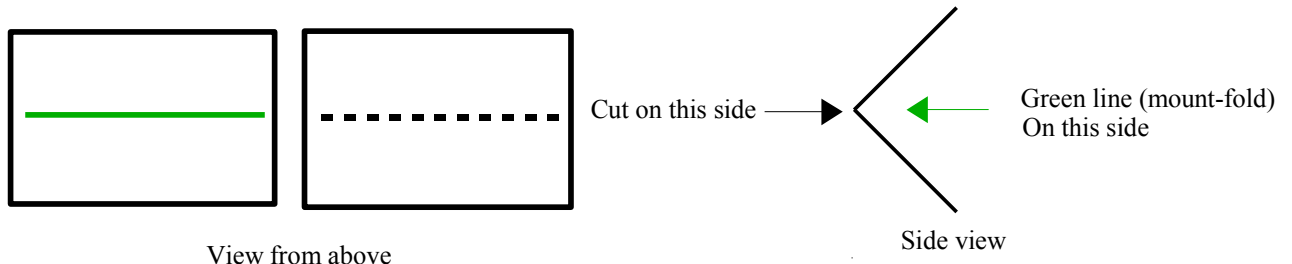

To create the mount-fold you have to cut into the paper at the side where the green line does NOT appear!!! To be able to perform this cut with high precision you should first take a puncture pen and puncture the exact beginning and ending points of the mount-fold (green or - - - - -) line ,then turn the paper and make the cut from puncture point to puncture point.

2) or ————— red line indicates a valley fold

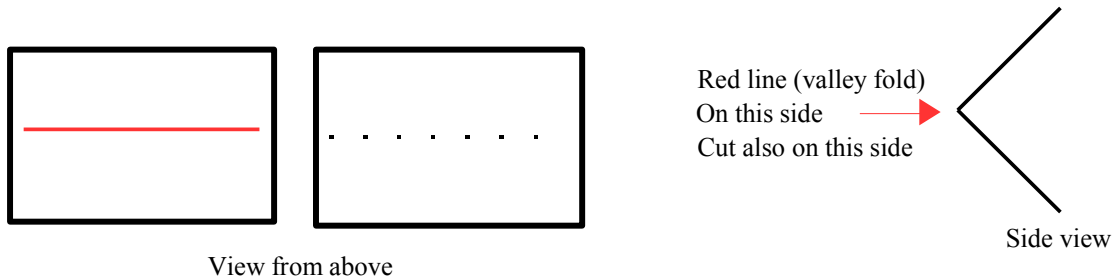

3) ————— Black line, is cutting line

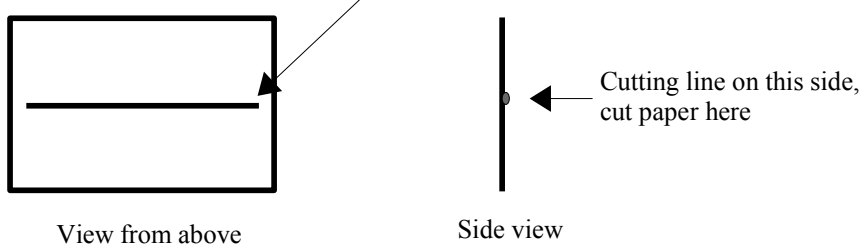

4) Moreover we need a basis fold line, which is the line where the model will be fold 90 degrees.

This is also a valley fold of —————
Personally I give this line another colour (—————) and I put this line on the entire width of the paper.

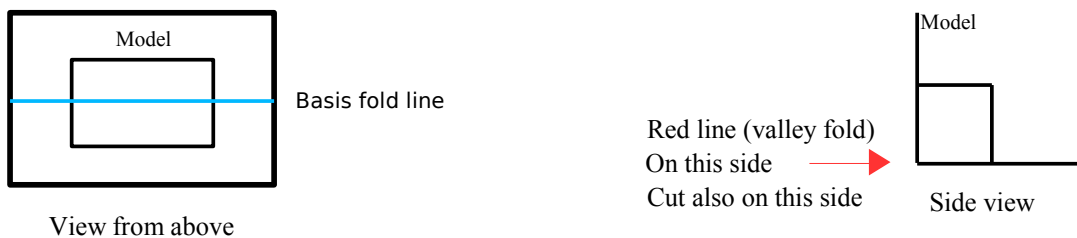

5) Attention

The lines of the model have been projected on the backside of basis paper. We expand the model to the front-side- and as a result we get to see the mirror Image of what we saw on the backside. So what was on the left side first will be found at the right now and vice versa .

Keep this in mind when creating the design. This is to avoid the church tower standing on the wrong side of the church.

All drawn lines are not visible at the front-side of the paper.

Cutting a mount or valley fold, requires however some practice. Take some basic Paper to test the correct depth must be.

Technique of devising

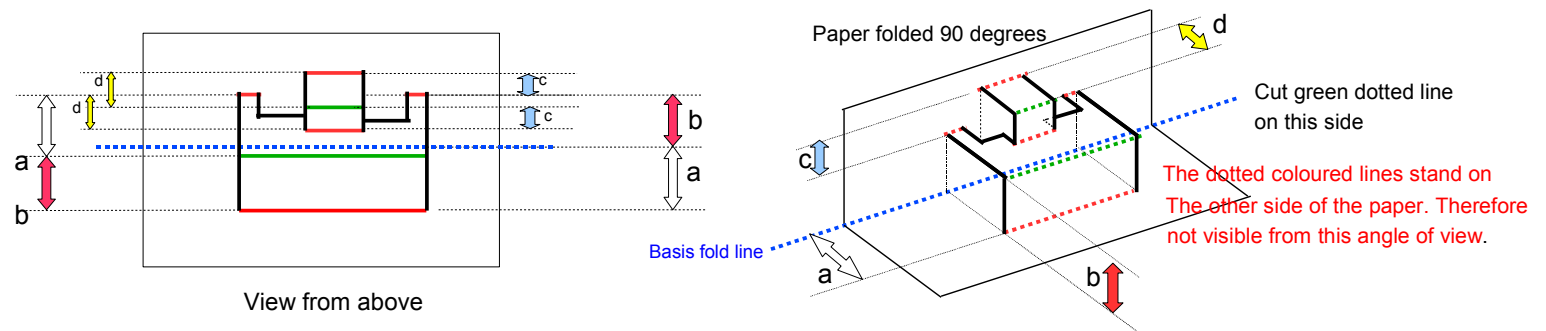
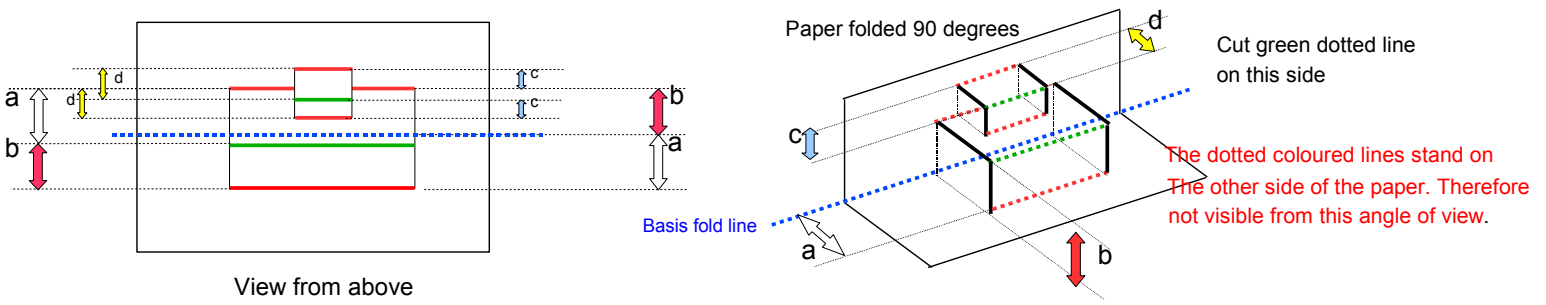
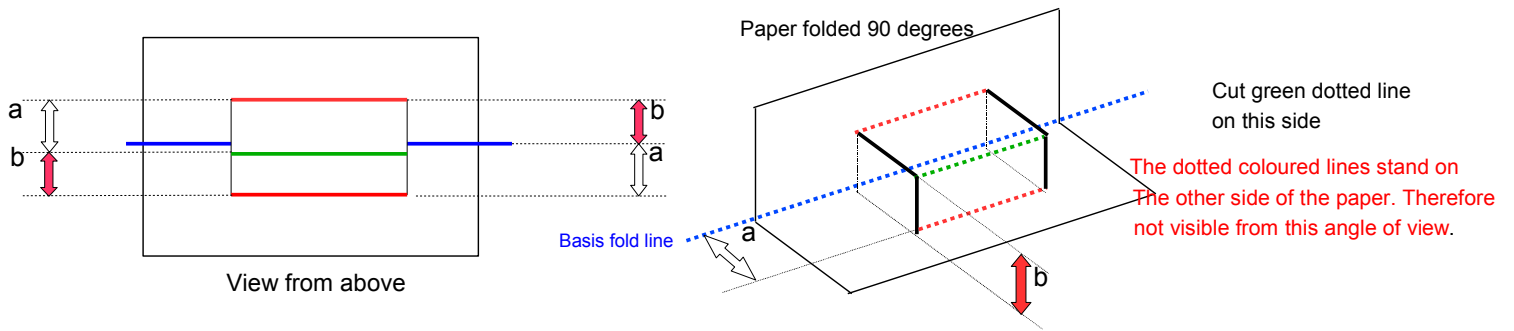

NOTE

ARROWS OF THE SAME COLOUR HAVE EQUAL DIMENSIONS, THESE DIMENSIONS CAN BE ADAPTED AT DISCRETION

Example of staircase

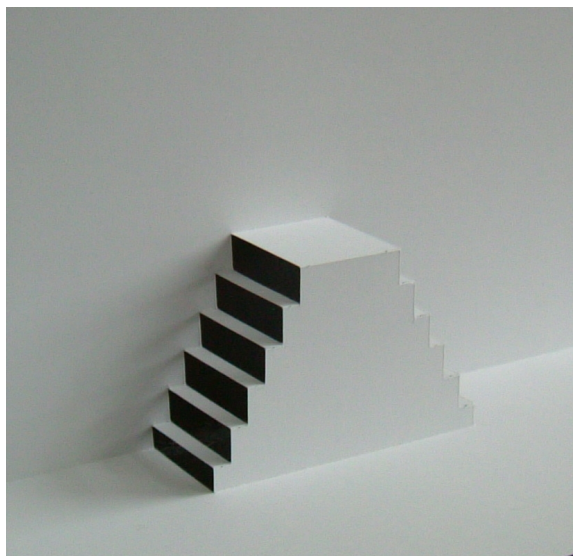
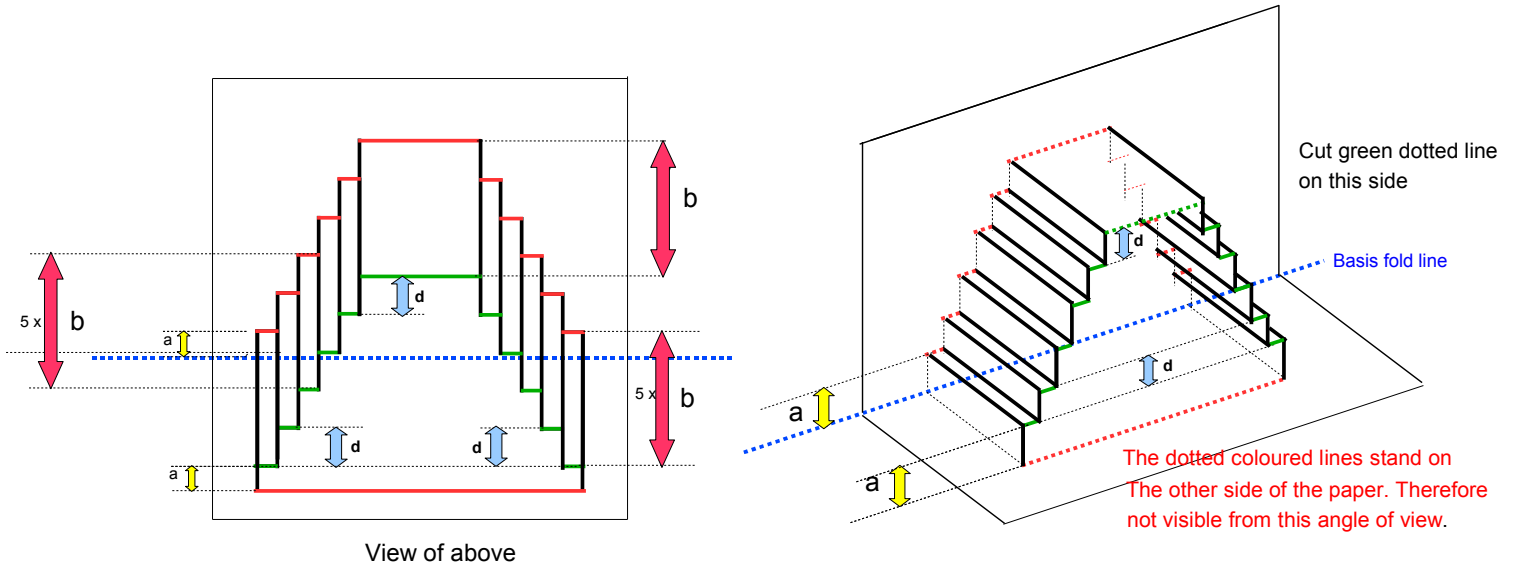

Example of "round"

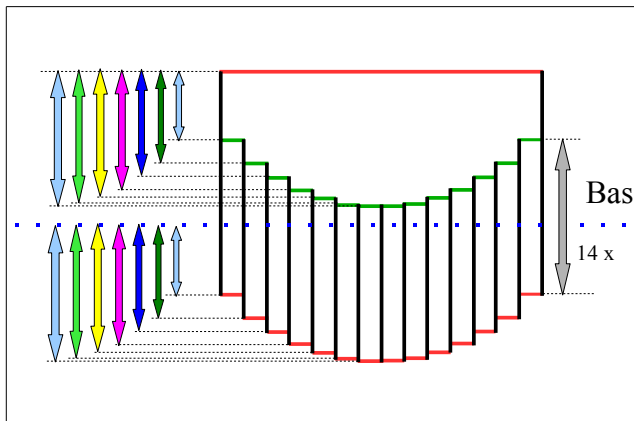

View of above

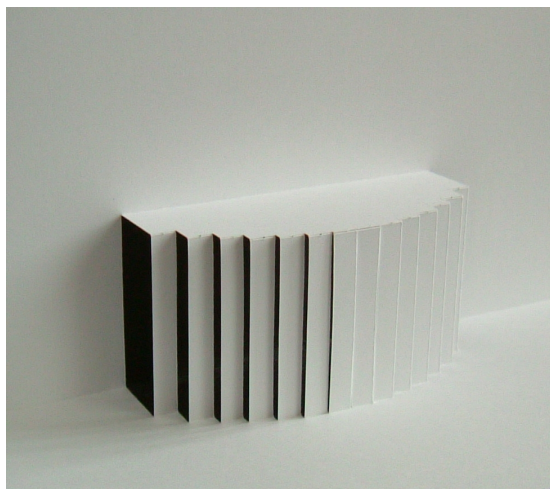
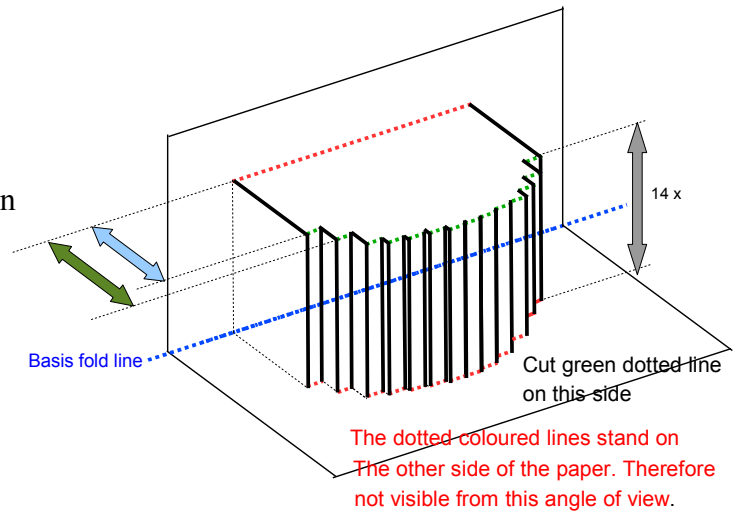

Example of slanting roof

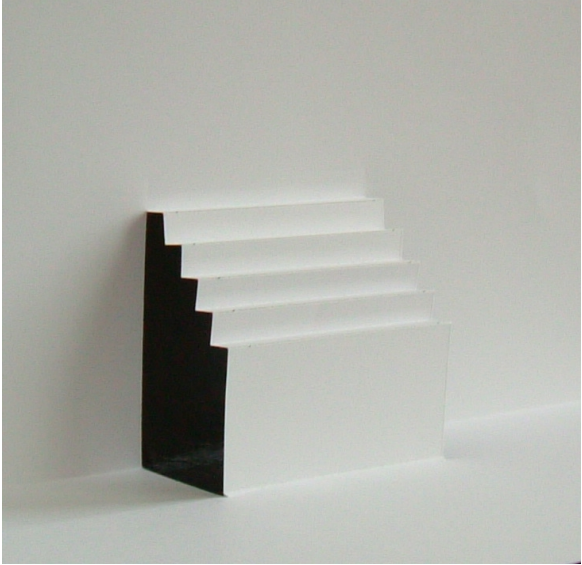
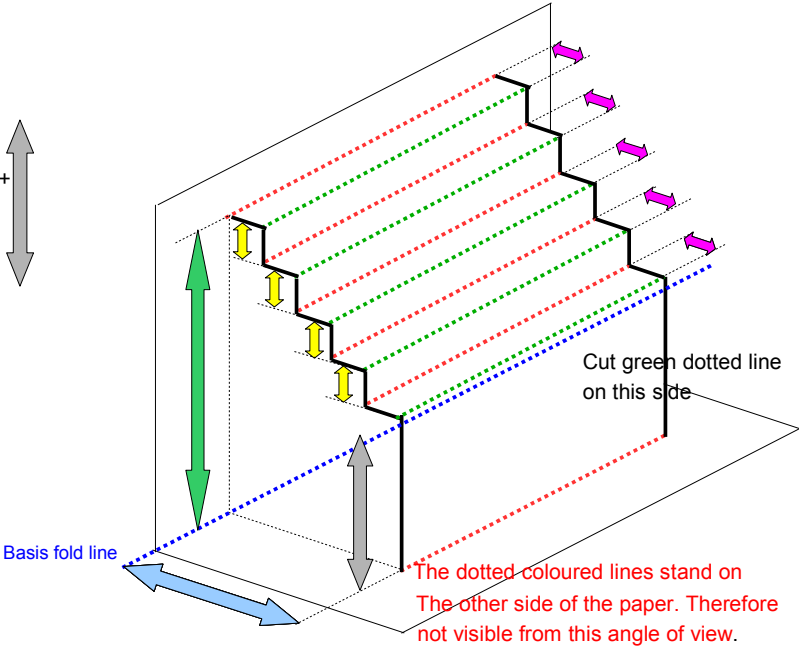
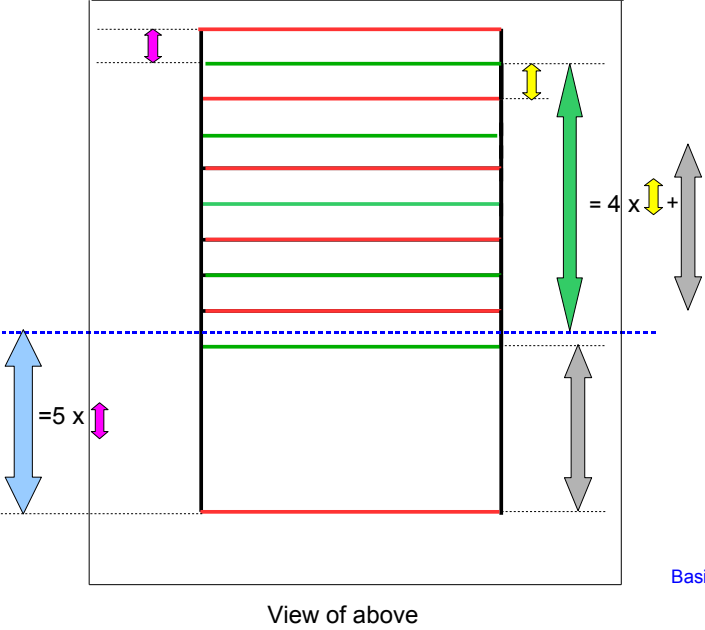

Example of "round 1"

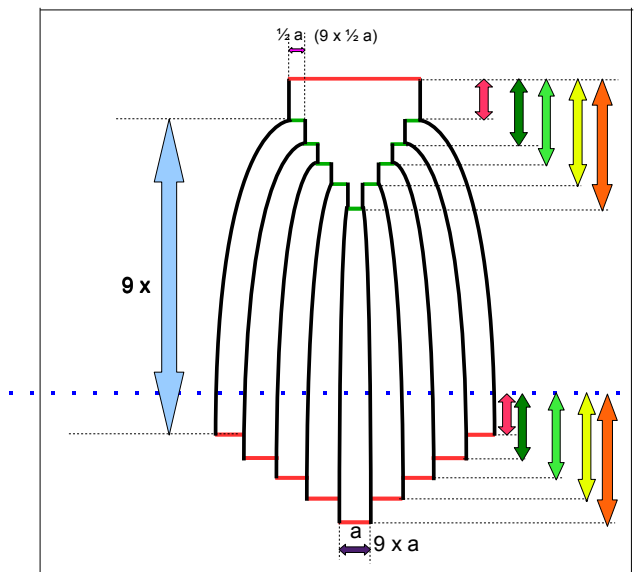

View of above

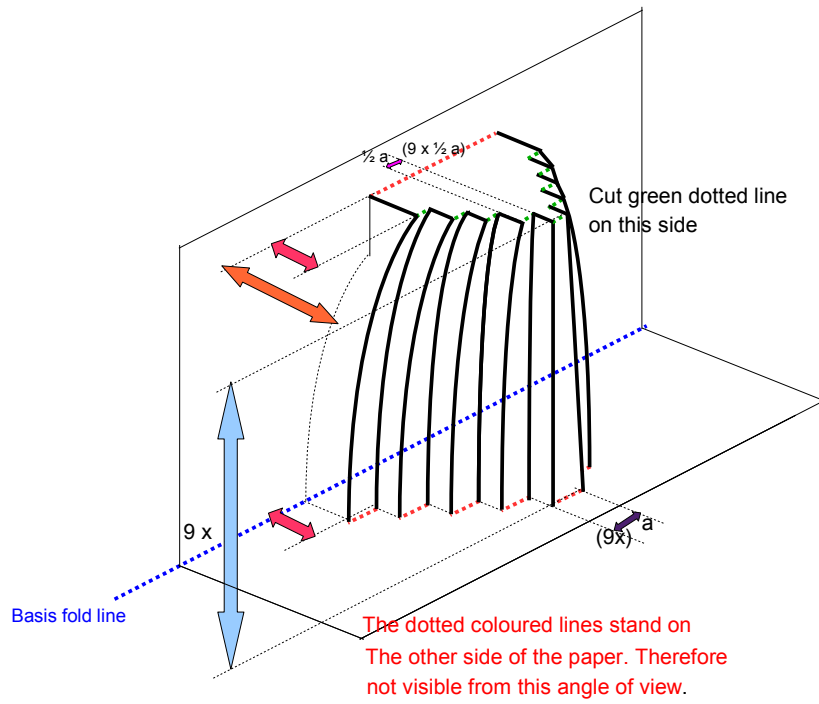

To cut and fold.

If the design is ready the cutting and folding follows. Cutting along a ruler gives the Best result. Folding is precise work that requires much patience. Especially the more complicated designs are sometimes difficult to fold. Take your time, one step At the time. Make try outs first and do not forget that the possibilities with paper are. Not indefinite. If something does not work out well, try simplifying the design.

General.

In this chapter, only folding and cutting 90 degrees (horizontal) models have been Explained. However,there are still many other possibilities in paper architecture, 180 degrees, 360 degrees and also 90 degrees (vertical).

But the basic instructions for all these forms remain the same.

Try and experiment to see which one is best or even try them all.

Many different types of paper are made of wood-fibres, these fibres run in a particular pattern. This can affect the way an model can be fold. The best solution is to fold against the fibre directions. With the 90 degrees cards most fold lines are horizontally, so again, fold the fibre direction as much as possible.

To figure out the way the fibres run on your piece of paper, you slightly bend the paper. If this not easy the fibres are horizontally, if it is easy to bend the paper the fibres run vertically.

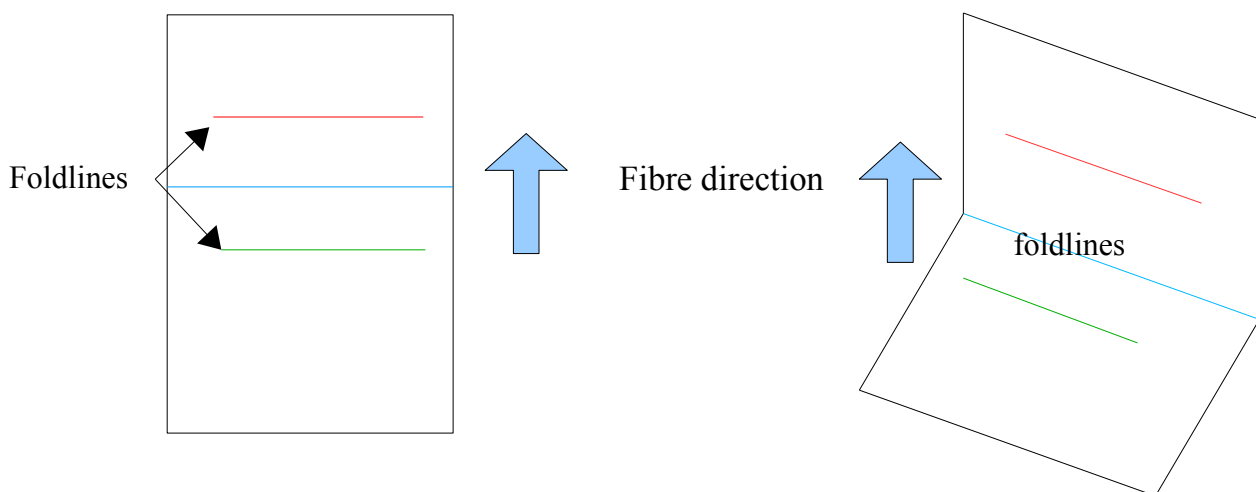

Appendix 1.
Making easy designs.

Car + Trailer

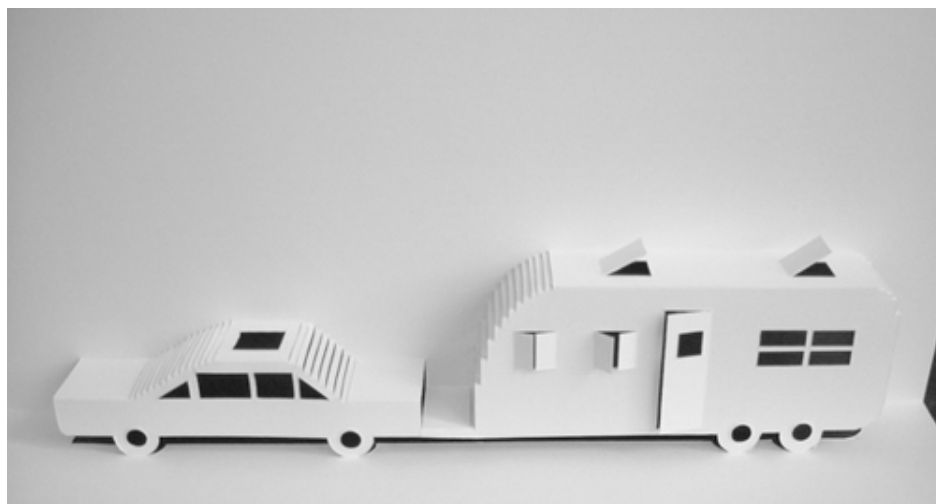
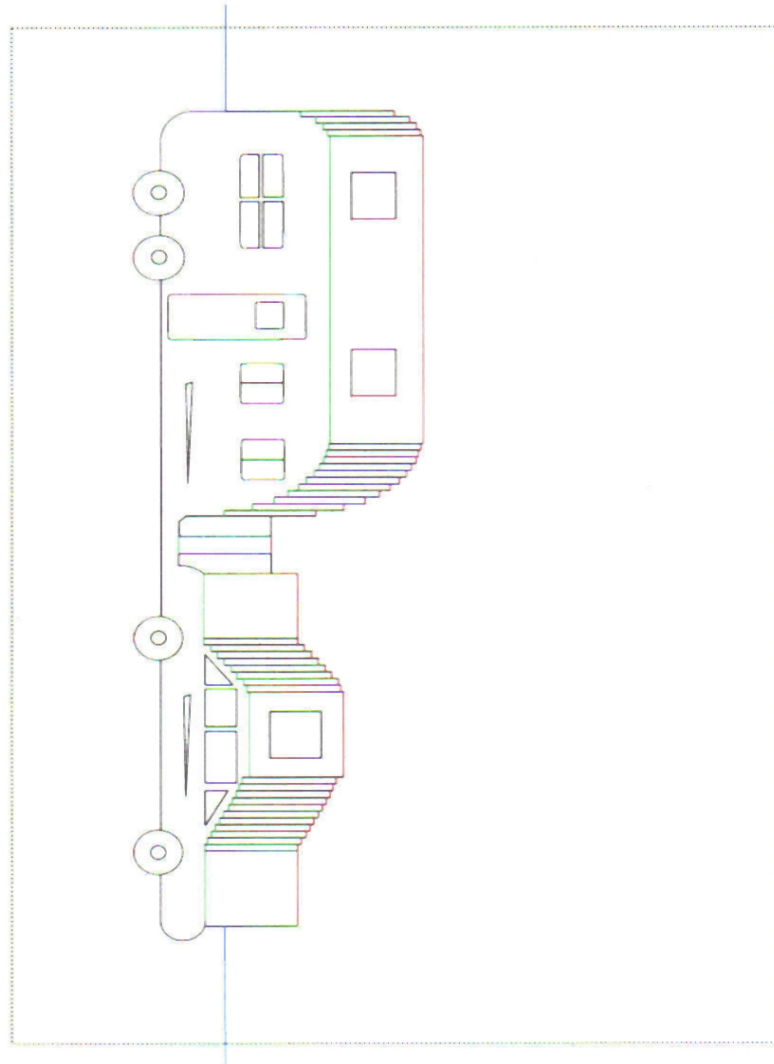

Lighthouse Big Red

